



Casaluci Giuliano
Healthy Design

DEGENZA
ALL WARDS

TOTEM CENTRALE HYDRA

HYDRA CENTRAL TOTEM



TOTEM CENTRALE HYDRA

HYDRA CENTRAL TOTEM

- Hydra è un elemento d'arredo con funzionalità integrate, ergonomico ed accessibile, progettato per il comfort ambientale delle camere di degenza;
 - Hydra rende facile la configurazione della sfera personale consentendo all'utente di regolare la dimensione intima e sociale del proprio spazio;
 - Hydra rende accessibili al degente gli oggetti per la cura e l'intrattenimento quotidiano;
 - Hydra organizza con intelligenza la camera di degenza ed assicura un elevato comfort ambientale;
 - Hydra crea uno spazio personalizzabile a misura di degente;
 - Hydra facilita il lavoro di assistenza e manutenzione;
 - Hydra ha due comodini con maniglia angolare antitrauma per l'accessibilità totale a tutti i lati;
 - Dimensioni, colore ed equipaggiamento sulle specifiche del cliente.
-
- Hydra item of furniture with integrated functionality, ergonomic and accessible, it is designed to offer comfort to anyone bedridden in hospital;
 - Hydra makes managing the personal sphere easier, enabling the user to adapt the dimensions of his/her own space to suit his/her social and intimate needs;
 - Hydra makes the objects necessary for the patient's daily care and entertainment more easily accessible;
 - Hydra organises the sick room intelligently and assures a high level of comfort;
 - Hydra creates a space which can be personalised to suit the patient;
 - Hydra renders the work of assistance and maintenance easier;
 - Hydra has two bedside tables with an angular antitrauma handle for total accessibility on all sides;
 - Dimensions, colour and equipment according to the client's specifications.

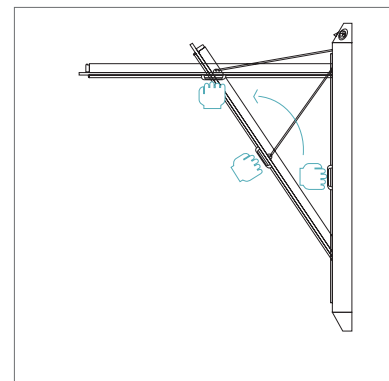

Sistema di apertura separè
Screen opening system

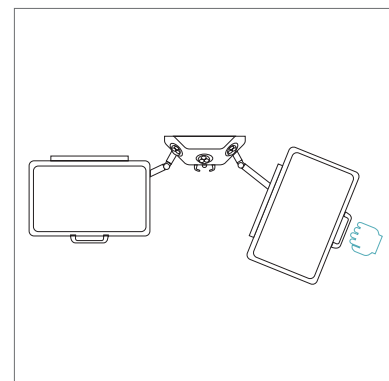

Accessibilità comodino
Bedside table accessibility

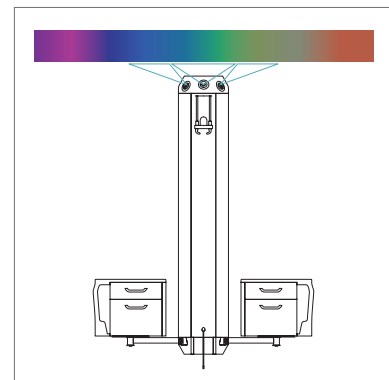

Cromoterapia
Chromotherapy

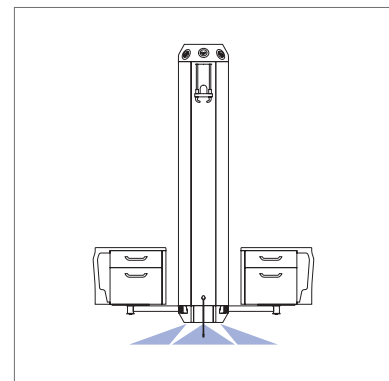

Illuminazione notturna di orientamento
Guiding night-light system



Casaluci Giuliano
Healthy Design

Modulo superiore per la cromoterapia

Upper module for chromotherapy

Sistema di prese a differenti altezze
per degenti ed operatori

Varying-height grip system for
patients and operators

Comodini sospesi con sistema di
rotazione e traslazione verso il paziente

Suspended bedside tables with a rotation
and shifting function towards the patient

Luci di orientamento notturno

Guiding night-lights

Sistema di separazione
ad apertura facilitata e sicura

Easy and safe system of
separation and opening



TOTEM CENTRALE HYDRA

HYDRA CENTRAL TOTEM

Il Totem HYDRA permette di integrare diverse funzionalità in un unico elemento d'arredo compatto e di facile installazione sospesa mediante ancoraggio a muro. HYDRA dispone di una tenda completamente a scomparsa (estraibile con un movimento basculante che non ingombra la stanza in fase di apertura) costituita da un innovativo tessuto in Bioactive, con trattamento antibatterico, che garantisce una corretta privacy, senza isolare completamente il paziente.

Il Totem HYDRA può integrare la funzionalità dei comodini degenza, sospesi mediante bracci articolati i quali facilitano l'utilizzo e l'accesso da parte del degente e semplificano la pulizia della stanza. Il comodino, inoltre è ruotabile in piena libertà su tutti i 360° per permettere l'accesso da tutti i lati.

Il Totem HYDRA può integrare unità di alimentazione per uso medico e per uso degente, posizionate a differenti altezze per facilitarne l'usabilità da parte dei diversi operatori.

Il Totem HYDRA può essere integrato nella parte superiore di apparecchi di illuminazione orientabile con sorgenti luminose a variazione cromatica o fissa, e di luce notturna di orientamento nella parte inferiore.

La possibilità di avere diverse configurazioni rende il prodotto applicabile in diversi ambienti, oltre che nelle degenze ospedaliere, può essere installato negli ambulatori medici, nei reparti di terapia intensiva e post operatori, e dove è necessario garantire una maggiore privacy.

Totem HYDRA makes it possible to integrate diverse functions in a single, compact piece of furniture which is easy to install and is suspended by means of anchorage to a wall.

Totem HYDRA includes a completely retractable curtain (extractable by means of a balancing movement that does not encumber the room during the opening phases) made from an innovative Bioactive fabric, with an anti-bacteriological treatment, that guarantees privacy without isolating the patient completely.

Totem HYDRA can integrate the usefulness of the bedside tables, suspended by means of articulated supporting arms which simplify use and access on the part of the patient and make cleaning the room easier. The bedside table is also completely revolving to allow access on all sides.

Totem HYDRA can integrate feeding units for medical use or by the patient, positioned at different heights to render it easier to use by various operators.

Totem HYDRA can be integrated in the upper part with adjustable, chromatically varying or fixed light sources, and guiding night-light in the lower part.

The possibility of having diverse configurations makes the product suitable for use in a range of spaces; as well as hospital wards, it could be installed in medical surgeries, in intensive care or post-op, and wherever it is necessary to guarantee greater privacy.



Finitura esterna in legno
External wood finishings



Con prese elettriche senza comodini
With electric sockets without bedside tables



Senza prese elettriche e comodini
Without electric sockets and bedside tables

Altri accessori, funzioni, soluzioni del totem possono essere implementate sulle specifiche del cliente.

Other accessories, functions and solutions for the totem can be implemented on clients' specifications.

TOTEM CENTRALE HYDRA

HYDRA CENTRAL TOTEM

Specifiche tecniche (mm)

Dimensioni totem con comodini	L1655xP785xH2440
Dimensioni totem senza comodini	L415xP145xH2440
Dimensioni tenda in posizione aperta	1940x1700
Altezza rullo tenda	1975
Distanza di schermatura a partire dalla parete	1950

Movimentazione comodini

Rotazione completa di 360°
Rotazione di 90° rispetto al muro di installazione

Carico massimo comodini..... Kg 15

Prese elettriche

Prese superiori per operatore sanitari: 2 universali, 2 bipasso, 1 interruttore
Prese inferiori degente: 1 universale, 2 bipasso
Altezza prese superiori mm 1660
Altezza prese inferiori..... mm 870
Orientamento luci cromatiche: da 0 a 60° rispetto all'orizzontale
Orientamento luci notturne: direzione fascio -60° rispetto all'orizzonte, apertura fascio 70°

Tutti i dati sono riferiti ad un'altezza di installazione consigliata pari a 160 mm dal pavimento.

Technical specifications (mm)

Dimensions of totem with bedside tables	L1655xd785xh2440
Dimensions of totem without bedside tables ...	L415xd145xh2440
Dimensions of curtain in open position	1940x1700
Height of curtain roller.....	1975
Distance of screen measured from wall	1950

Movement of bedside tables



360° rotation
90° rotation with regard to the installation wall

Bedside table max. load..... Kg 15

Electric sockets

Upper sockets for health operators: 2 universal, 2 universal socket, 1 switch
Lower Sockets for patient: 1 universal, 2 universal socket
Height of upper sockets mm 1660
Height of lower sockets mm 870
Adjustable positioning of chromatic lights: from 0 to 60° with regard to the horizontal position
Positioning of night-lights: direction of the guiding strip -60° with regard to the horizontal, angle width of strip 70°

All the data refer to a recommended height of installation at 160 mm from floor level.

Colori totem Totem colours							
 S1 - rosa nespola S1 - medlar pink	 S2 - verde papiro S2 - papyrus green			 S3 - blu zaffiro S3 - sapphire blue			
 S4 - giallo savana S4 - savannah yellow	 S5 - avorio S5 - ivory			 C6 - bianco ghiaccio C6 - ice white			
Colori tessuto Fabric colours							
 02	 05	 06	 08	 18	 21	 56	 62
Colori comodino Bedside table colours							
 S1 - rosa nespola S1 - medlar pink	 S2 - verde papiro S2 - papyrus green			 S3 - blu zaffiro S3 - sapphire blue			
 S4 - giallo savana S4 - savannah yellow	 S5 - avorio S5 - ivory			 C6 - bianco ghiaccio C6 - ice white			
Colori maniglia angolare Colours of angular handle							
 M1 - carta da zucchero M1 - blue				 M2 - grigio chiaro M2 - pale grey			

In fase d'ordine è possibile personalizzare il totem con ulteriori colori – I colori riportati nella tabella sono solo indicativi.
At the moment of ordering, it is possible to personalise the totem with other colours – the colours suggested in the table are just an indication.



Casaluci Giuliano
Healthy Design

www.casalucigiuliano.it

CASALUCI GIULIANO S.r.l.

Via Provinciale per Corigliano km 1 – 73020 Castrignano de' Greci (LE) Italy
Tel. +39 0836 583 339 Fax +39 0836 589 136 info@casalucigiuliano.it